

VMC APC Series Specifications

		600 APC	860 APC	1100 APC
Table				
Table Size	mm	600 x 400	850 x 500	1000 x 500
Working Area	mm	600 x 500	860 x 560	1100 x 560
T-Slot	mm	14 x 3 x 100	18 x 5 x 100	18 x 5 x 100
Max Table Load / Each	kgs	200	250	300
Travel				
X/Y/Z Axis Travel	mm	610 x 500 x 500	860 x 560 x 600	1100 x 560 x 600
Spindle Nose To Table Surface	mm	65~565	110~710 (70~670)	110~710 (70~670)
Spindle				
Spindle Taper		ISO 40	ISO 40 (ISO 50)	
Spindle Speed	rpm	10000 (12000,15000)	8000 (10000, 12000, 15000) (ISO50: 6000, 8000, 10000)	
Transmission Method		Belt (Direct, ZF)		
Spindle Motor	kw	5.5/7.5 (7.5/11)	7.5/11 (11/15, 15/18.5)	
ATC				
Magazine Capacity	tools	24 (30)	24 (30,36) (ISO50: 20, 24)	
Tool Selection Method		Random		
Max Tool Diameter/ W/O Adjacent	mm	Ø76/ Ø150	Ø75/Ø150	
Max Tool Weight / Length	kgs/mm	6/300	7/300 (ISO50: 15/350)	
Tool Shank Specifications		ISO-40	ISO-40 (ISO-50)	
Tool Change Time	sec	T-T 2.3, C-C 4.5 (T-T 1.8, C-C 3.8)		
Auto Pallet Changer				
Clamp Force		Hydraulic/50 -50kg/cm ²)		
Clamp Method		4 Tapper Cone/Pull Stud		
Change Cycle Time	sec	7 (±1)		
APC Lift Force	kgs	3600		
APC Net Weight	kgs	450	500	550
3 Axis Traverse				
3 Axis Cutting Feedrate	m/min	10	12	
3 Axis Rapid Traverse	m/min	36/36/36	36/36/30 (48/48/36)	30/30/24 (36/36/30)
Drive Motors				
Chip Conveyor	hp	1/4		
Coolant Motor	hp	3/4		
Flush Motor	hp	3/4 x 2		
Coolant Tank	ℓ	300	350	400
Others				
Packing Size (L x W x H)	mm	2250 x 3700 x 2450	2300 x 4700 x 2450	4200 x 2300 x 2450
Machine Size (L x W x H)	mm	3200 x 3400 x 3010	3460 x 3680 x 3260	4110 x 3160 x 3260
Net Weigth / Gross Weight	kgs	6000/6500	8100/8500	8700/9100

■ Description in () are optional accessories.

■ We reserve the right to modify the design and specification without notice in advance. Above specifications are for reference only. Correct specifications are based on actual machine.



Zero Downtime for Loading Twin APC for High Volume Production

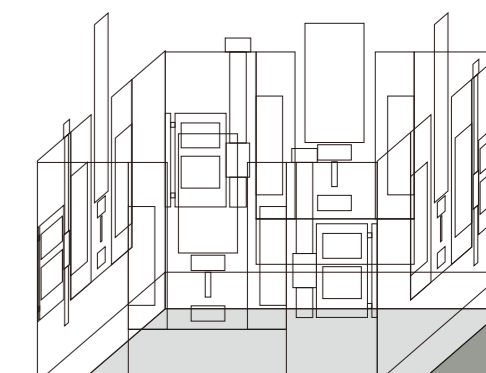

FOCUS SEIKI CORP

No.11, Lane 181, Da Ming Road,
Shengang Dist., Taichung City,
42949 Taiwan

Tel: +886-4-2529-5611

Fax: +886-4-2529-5613

E-mail: sales@focuseiki.com.tw

www.focuseiki.com.tw

Vertical Machining Center
with APC

VMC 600 APC | 860 APC | 1100 APC

- Y Axis Extra Large Travel 560 mm
- Attractive Fully Enclosed Design
- Extra Wide Base Design 1.3m
- Options
 - (1) Double 4th Axis
 - (2) Hydraulic Control Valve
 - (3) Pneumatic Control Valve
- Full Enclosure Avoids Leakage During Operation
- Additional Control Panel on Tool Magazine For Easy Tool Loading / Unloading
- APC Series Include Chip Conveyor to Enhance Productivity
- Slant Design Base & APC Allow Easy Chip Flushing, Avoids Chips Adhering To Structure
- Four Way Swiveling Control Panel For Operator Convenience
- Reservoir-Type Lubricator Bronze Tube Oil Circuit
- Direct Type Spindle Motor Cooling Device



Tooling Brackets Increase Production Efficiency



Grundfos Chip Flush Pump Greatly Enhances APC Stability

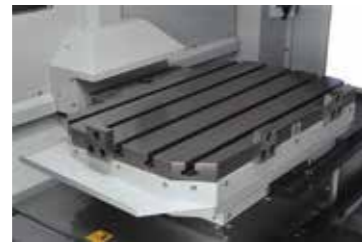

Chip Resistant Worktable - Special Internal Covers Prevent Chips Dropping Into The Machine When The APC is in Operation



Enhanced Screw Pretension Design

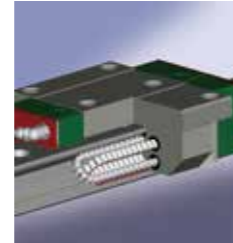

High Rigidity Roller Type Linear Guide



Heavier Loading Higher Stability

Hydraulic Clamping on Auto Pallet Changer

Independent Pneumatic Reservoir For ATC

Hydraulic Rotating Auto Pallet Changer (Exchange Time: 7 ± 1 Sec)

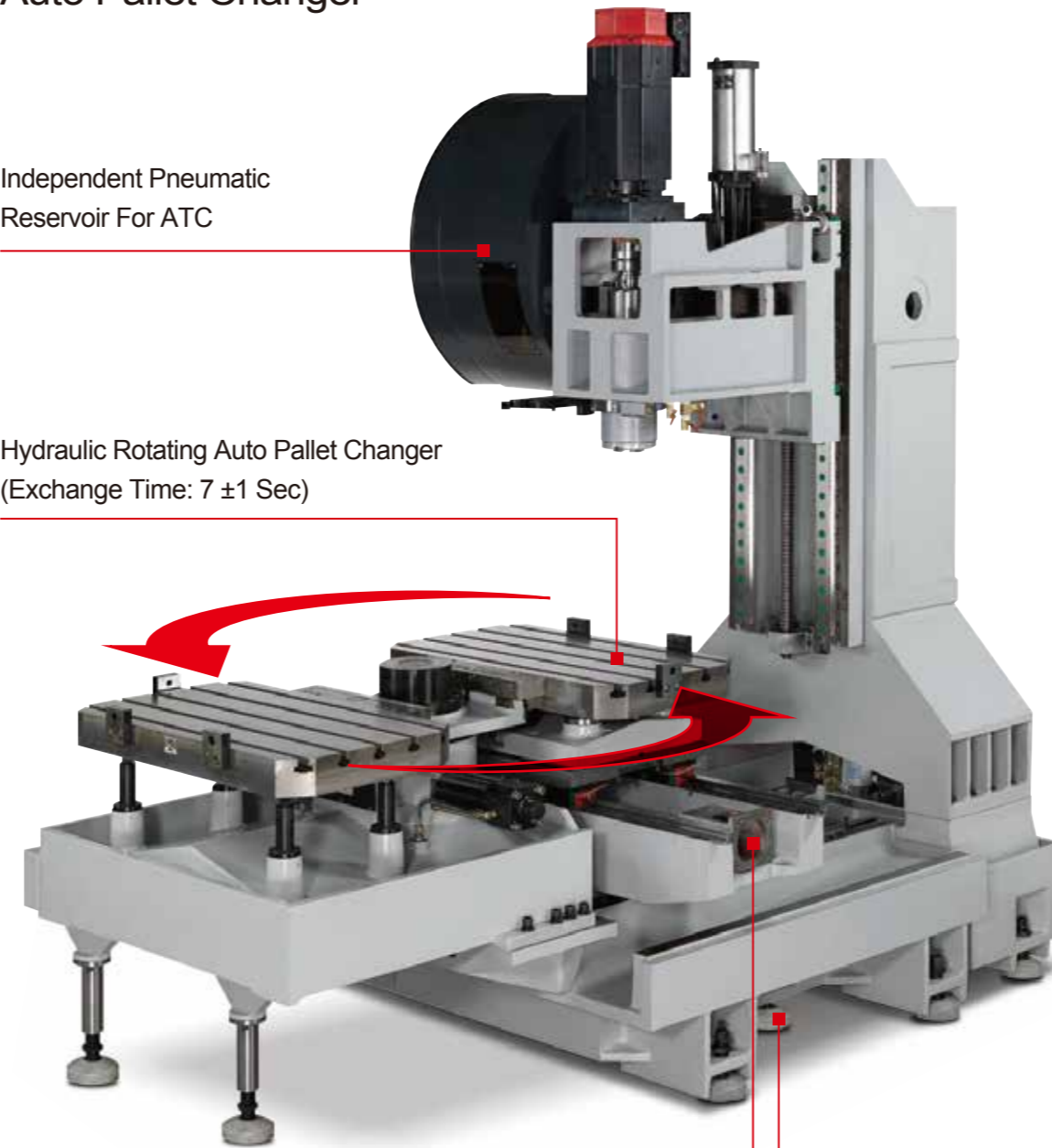

X/Y/Z Axes Adopted Roller Type Linear Guideways

Eight Leveling Bolts for High Stability Design (1 Close to Y Axis Track To Avoid Deformation)

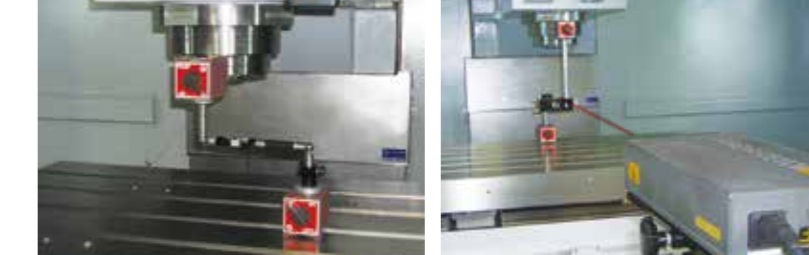

- Ball Bar Test
- Laser Calibration
- Spindle Dynamic Balance

Max. Production Components



Bedplate



Cylinder Head



Clutch Housing



Manifold

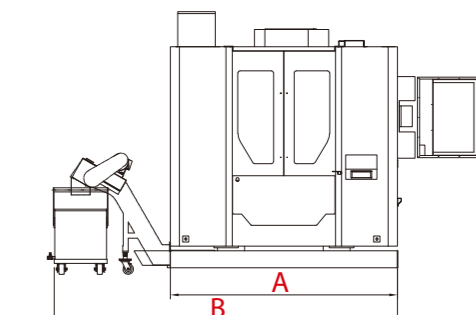
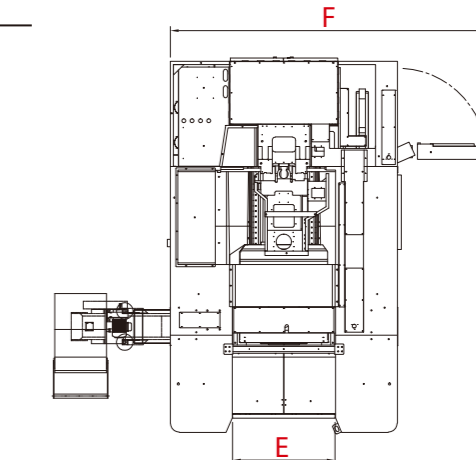

Dimensions

	A	B	C	D	E	F
600APC	1980	3200	3400	Min 2510 Max 3010	760	2780
860APC	2240	3460	3680	Min 2660 Max 3260	900	3080
1100APC	2940	4160	3725	Min 2660 Max 3260	1200	3820

HEIDENHAIN QAN 260M Series Torque Characteristic Curve

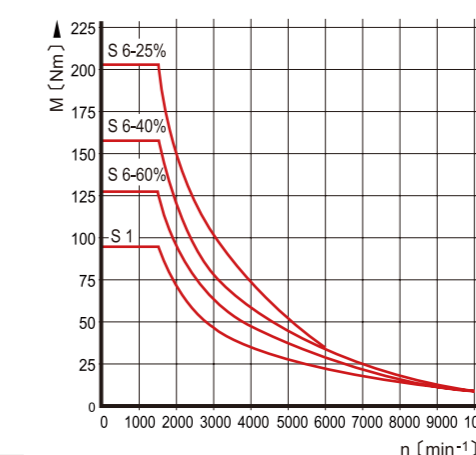

MISTUBISHI SJ-V11 Series

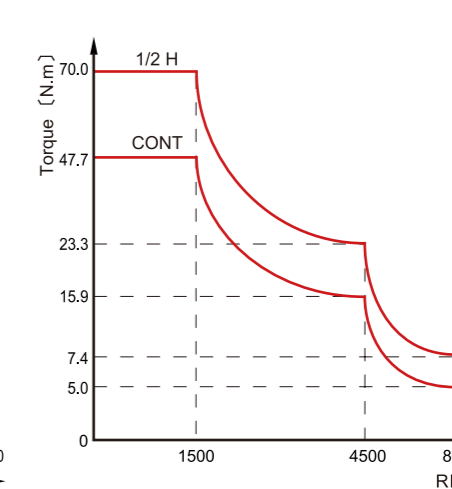

FANUC α Series

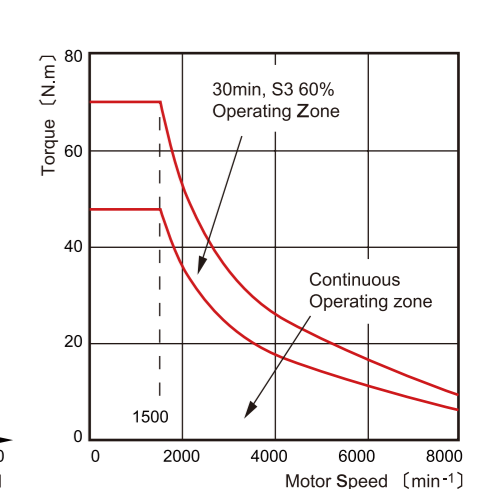

Standard Accessories:

- Arm Type ATC (24 Tools)
- Fully Enclosed Guard
- Swiveling Control Box
- Work Light & Alarm Light
- Volumetric Type Automatic Lubricator
- Coolant & Chip Flushing System
- Auto Power Off
- Rigid Tapping
- Tool Box
- Leveling Screws & Blocks
- Operation Manual
- Mechanical Oil Coolant Separator

Optional Accessories:

- Air Gun
- Coolant Gun
- Coolant Through Spindle (CTS)
- Transformer
- Chip Conveyor
- Linear Scale
- Auto Tool Length Measurement System
- Auto Workpiece Measurement System
- Air Conditioner